



POLICY ROUNDTABLE ON ESCerts TRADING



BUREAU OF ENERGY EFFICIENCY

(A Statutory body under Ministry of Power, Government of India)

VENUE: BEE Conference Room, 4th Floor, Sewa Bhawan, R. K. Puram, New Delhi – 110 066
6th August, 3:00 PM

EVOLUTION OF PERFORM ACHIEVE & TRADE (PAT)

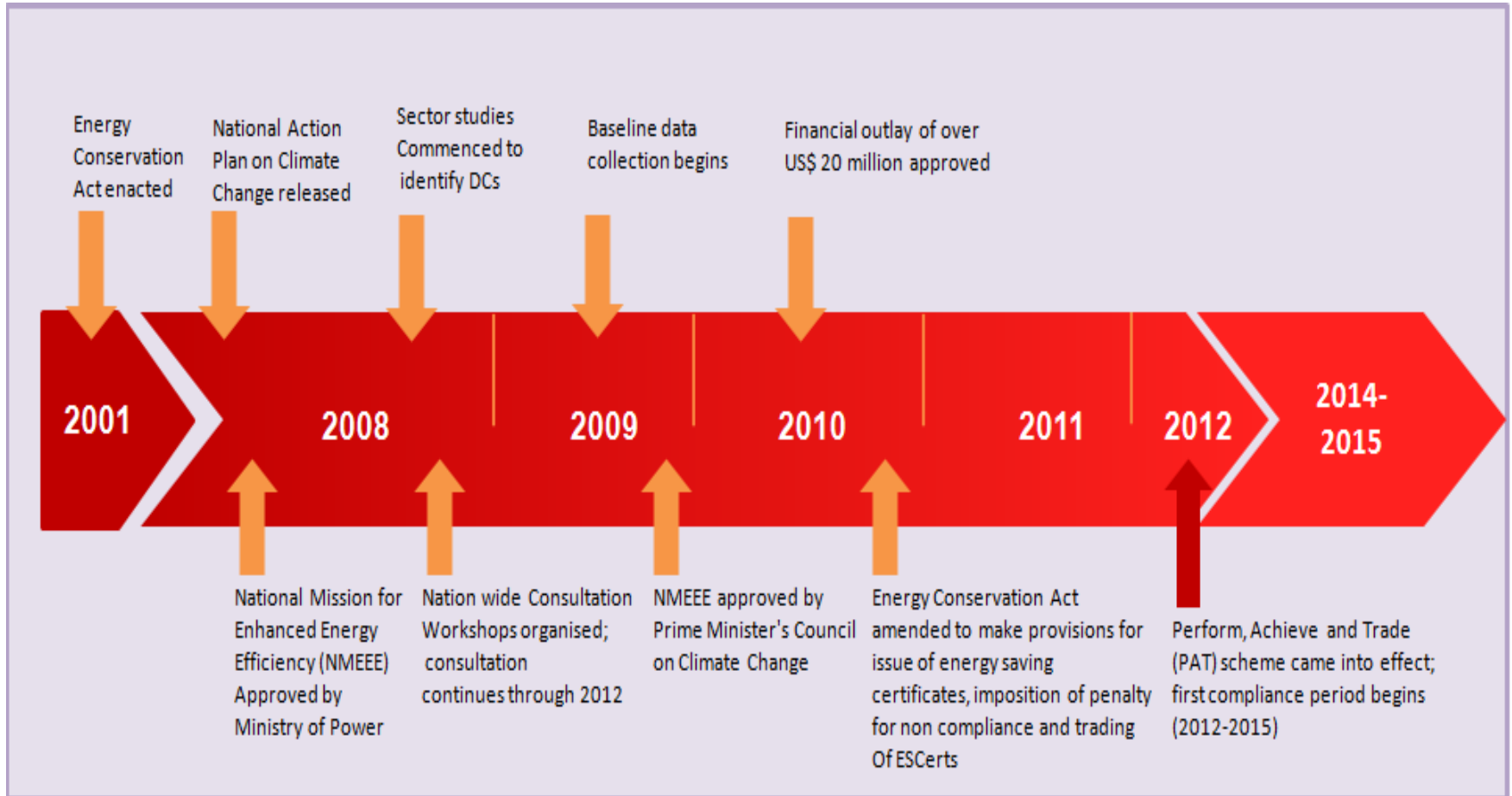

INTRODUCTION TO PAT SCHEME

- ✓ The Ministry of Power, in consultation with the Bureau of Energy Efficiency, has prescribed energy consumption norms and standards. [under clause (g) and (n) of section 14 of the Energy conservation Act 2001 for Designated Consumers – vide SO 687 (E)].
- ✓ The notification is based on the rules under GSR 269 (E), dated 30 March, 2012, herein referred as PAT Rules, 2012.
- ✓ PAT Cycle I covers 478 designated consumers (DC) of eight energy intensive sectors :
 - Aluminum, Cement, Chlor-alkali, Fertilizer, Iron and Steel, Pulp and Paper, Textile and Thermal power plant
 - The approximate reduction in the average energy consumption by 2014-15:- **4.05%**
 - Annual energy saving of about **6.686 million tonnes of oil equivalent (mtoe)**
 - Annual reduction of carbon dioxide emission is about **23 million tonnes**

INTRODUCTION TO PAT SCHEME...Cont.

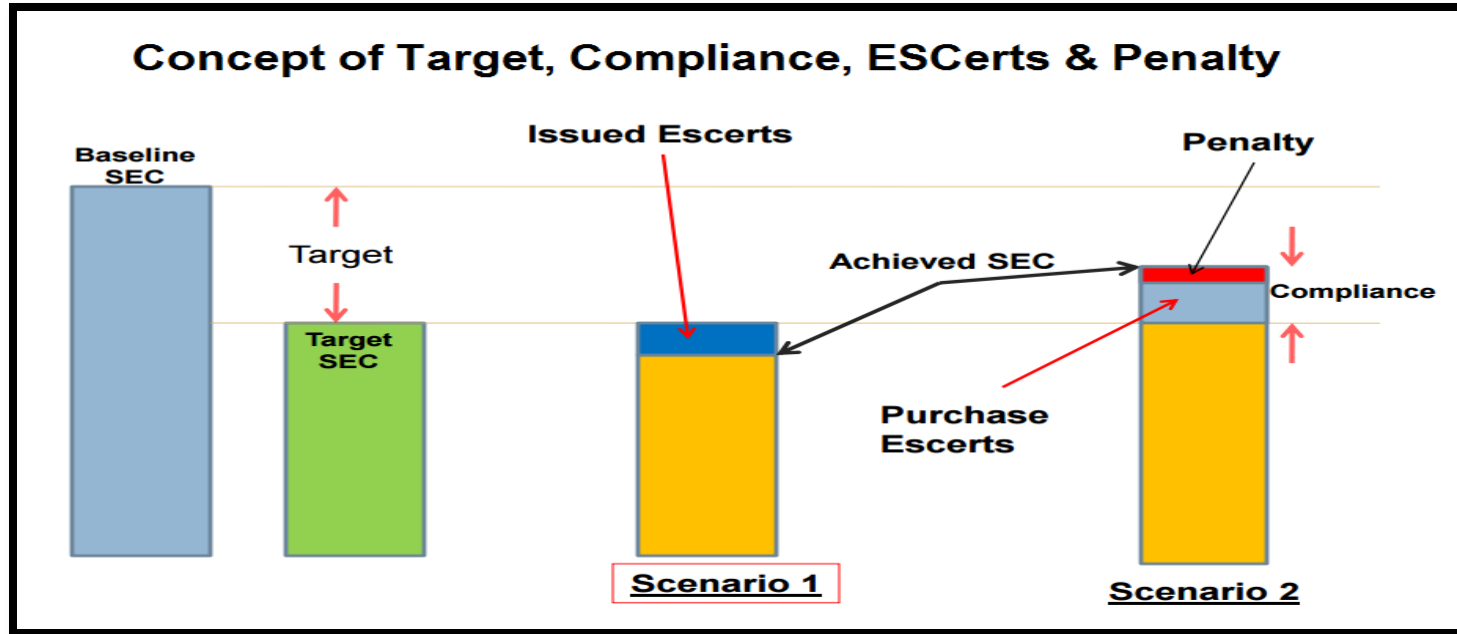

- ✓ Quantified energy savings are converted into Energy Saving Certificates (ESCerts).
- ✓ When a designated consumer achieve and surpass the target, the ESCerts are to be issued by Central Government and the same can be sell to the designated consumer who fails to achieve their targets to comply the energy consumption norms and standards.

Entities Involved in ESCerts Trading:

- ✓ Bureau of Energy Efficiency (BEE)
- ✓ Central Electricity Regulatory Commission (CERC)
- ✓ Power System Operation Corporation (POSOCO)
- ✓ Power Exchanges (PXs)
- ✓ Eligible Entity (EE) [Designated Consumers (DC)]

PROGRESS SO FAR...

- ✓ Finalization of Roles and Responsibilities of Entities Involved
- ✓ Finalization of ESCerts Exchange Regulations
- ✓ Up-gradation of PATNet Portal including M & V process, ESCerts Issuance, Check Verification Process, Trading, Compliance Process, Banked ESCerts.
- ✓ Ministry of Power (MoP) authorized official for online issuance
- ✓ Determination of value of one ESCert
- ✓ Manual on Penalty & Adjudication Process
- ✓ Formulation of Business Procedures for ESCerts Exchange on Power Exchanges

OBJECTIVE:

- ✓ To define a framework for trading of Energy Savings Certificate on Power Exchanges to facilitate the trading component of Perform, Achieve and Trade (PAT) scheme under NMEEE.
- ✓ The Regulation covered the definitions, functions of the Commissions & the Bureau, Category of Certificates, dealing of ESCerts, pricing of Certificate, fees and charges, market oversight, power to Relax.

ESCERT EXCHANGE REGULATIONS - DEFINITIONS

- ✓ **EXCHANGE OR TRADE OF ESCerts:** Sell or purchase of ESCerts under the Perform, Achieve and Trade (PAT) scheme on Power Exchanges, Including the delivery of ESCerts.
- ✓ **ELIGIBLE ENTITY:** Any Designated Consumer registered with Registry who has been issued or deemed to have been issued ESCerts and desire to sell or purchase ESCerts for compliance with the energy consumption norms and standards under clause (g) of section 14 of the EC Act.
- ✓ **POWER EXCHANGE:** Means the power exchange as defined in Power Market Regulations of the Commission.
- ✓ **POWER MARKET REGULATIONS:** Power Market Regulations means the Central Electricity Regulatory Commission (Power Market) Regulations, 2010 and as amended from time to time.
- ✓ **REGISTRY:** Registry means POSOCO or any other agency appointed by the Commission for management of exchange of ESCerts.

ROLE OF REGISTRY

- ✓ Assist in registrations process of ESCerts including crediting of ESCerts to DCs.
- ✓ The agency may collect fees and charges, approved by the commission in consultation with Bureau for the purpose of meeting the cost and expense towards the management of Registry and software platform.
- ✓ Management of ESCerts trading/ exchange.
- ✓ Coordination and information dissemination with DCs, Power Exchanges, BEE and Commission.
- ✓ Assist in development of IT platform along with guidance on hardware infrastructure for maintaining database of ESCerts and records of trading of ESCerts.
- ✓ Any other function, as suggested by CERC and BEE, after assessment of the real market conditions and execution of the trading mechanism.

DEALING IN ENERGY SAVINGS CERTIFICATE (ESCerts)

- ✓ Exchange of ESCerts shall be in accordance with the approved rules and bye-laws of respective Power Exchanges.
- ✓ The frequency of exchange of ESCerts shall be on monthly basis or in such periodicity as approved by the Commission.
- ✓ All eligible entities who intend to participate in the exchange of ESCerts shall register themselves with the Registry and Power Exchange.
- ✓ Eligibility Entity can exchange the ESCerts on a Power Exchange either directly or through a Member of a Power Exchange.
- ✓ In any trading session, an eligible entity shall not place sale bids in excess of total ESCerts held in its Registry Account. In case of breach, such eligible entities shall be treated as defaulter and any bid submitted by such eligible entity shall not be considered by the Power Exchange for the purpose of price discovery.

UP-GRADATION OF PATNet PORTAL

DESIGNATED CONSUMER (DC) DASHBOARD



M & V STATUS	ESCerts ISSUANCE	CHECK VERIFICATION	TRADING	COMPLIANCE	ESCerts BANKED
--------------	------------------	--------------------	---------	------------	----------------

M & V STATUS	ESCerts ISSUANCE	CHECK VERIFICATION	TRADING	COMPLIANCE	ESCerts BANKED
--------------	------------------	--------------------	---------	------------	----------------

DC Registration Number	DC Name	PAT Cycle	FORM 1			FORM A	FORM B
			FIRST YEAR	SECOND YEAR	THIRD YEAR		
PNP026PB	ABC Paper Limited, Hoshiarpur	Cycle I	SUBMIT/VIEW	SUBMIT/VIEW	SUBMIT/VIEW	SUBMIT/VIEW	VIEW
		Cycle II	SUBMIT/VIEW	SUBMIT/VIEW	SUBMIT/VIEW	SUBMIT/VIEW	VIEW

PROCESS FLOW FOR ISSUANCE OF ESCerts

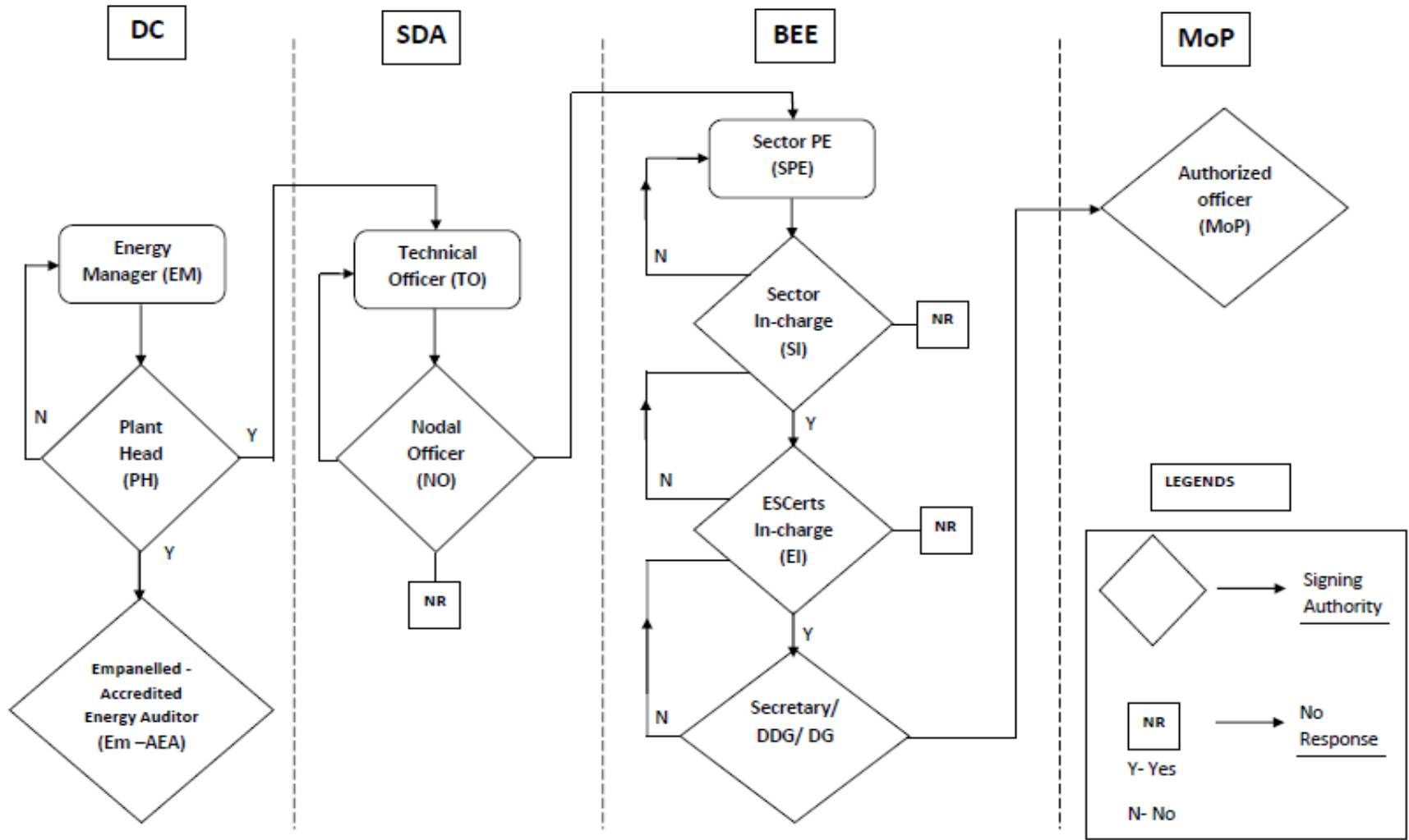

NR: No Response – Notification is issued to the head of the department and to the next officer in the channel

PROCESS FLOW FOR ISSUANCE OF ESCerts Cont...

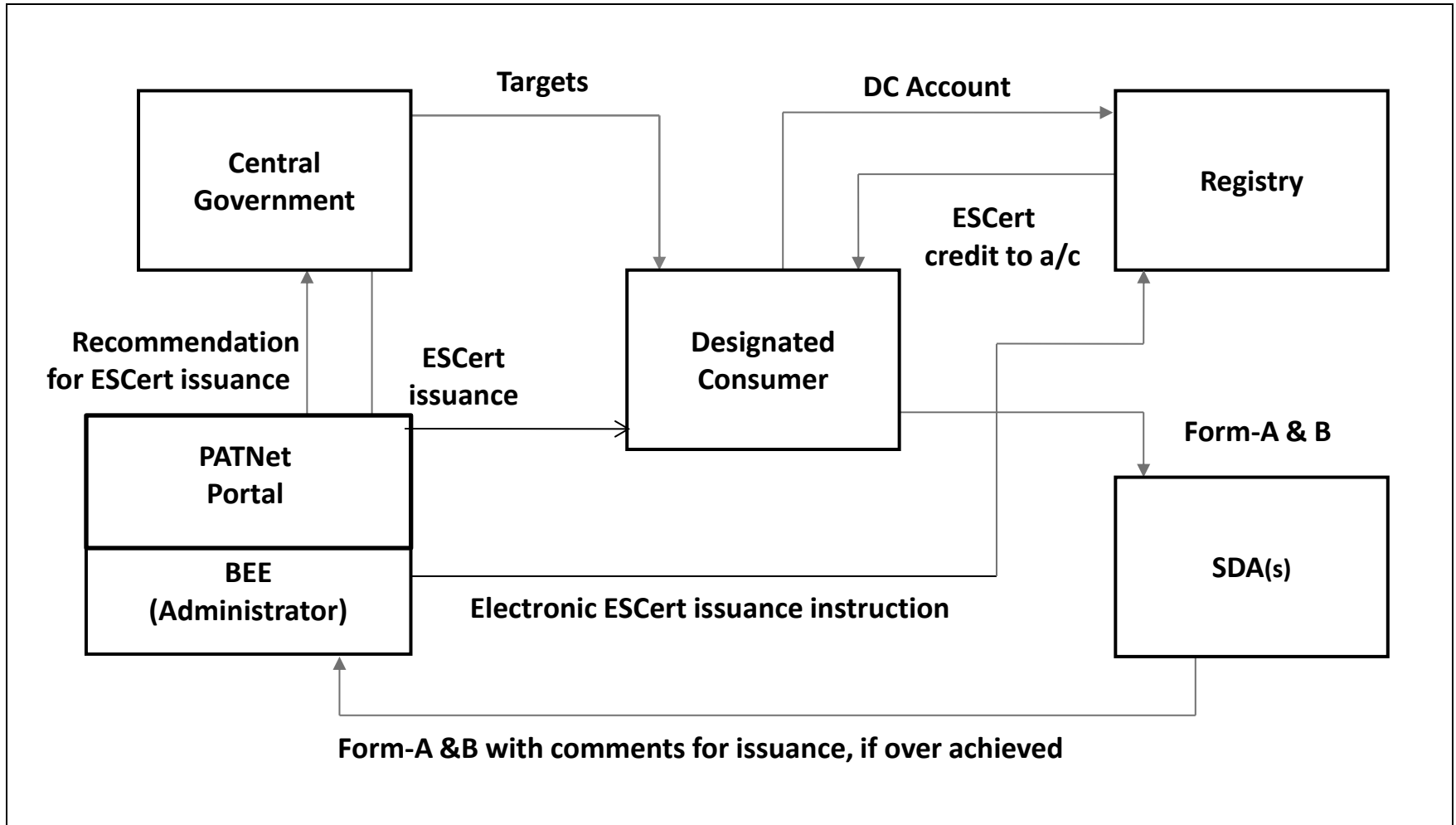

PROCESS FLOW FOR ESCerts TRADING

Market Regulator: CERC

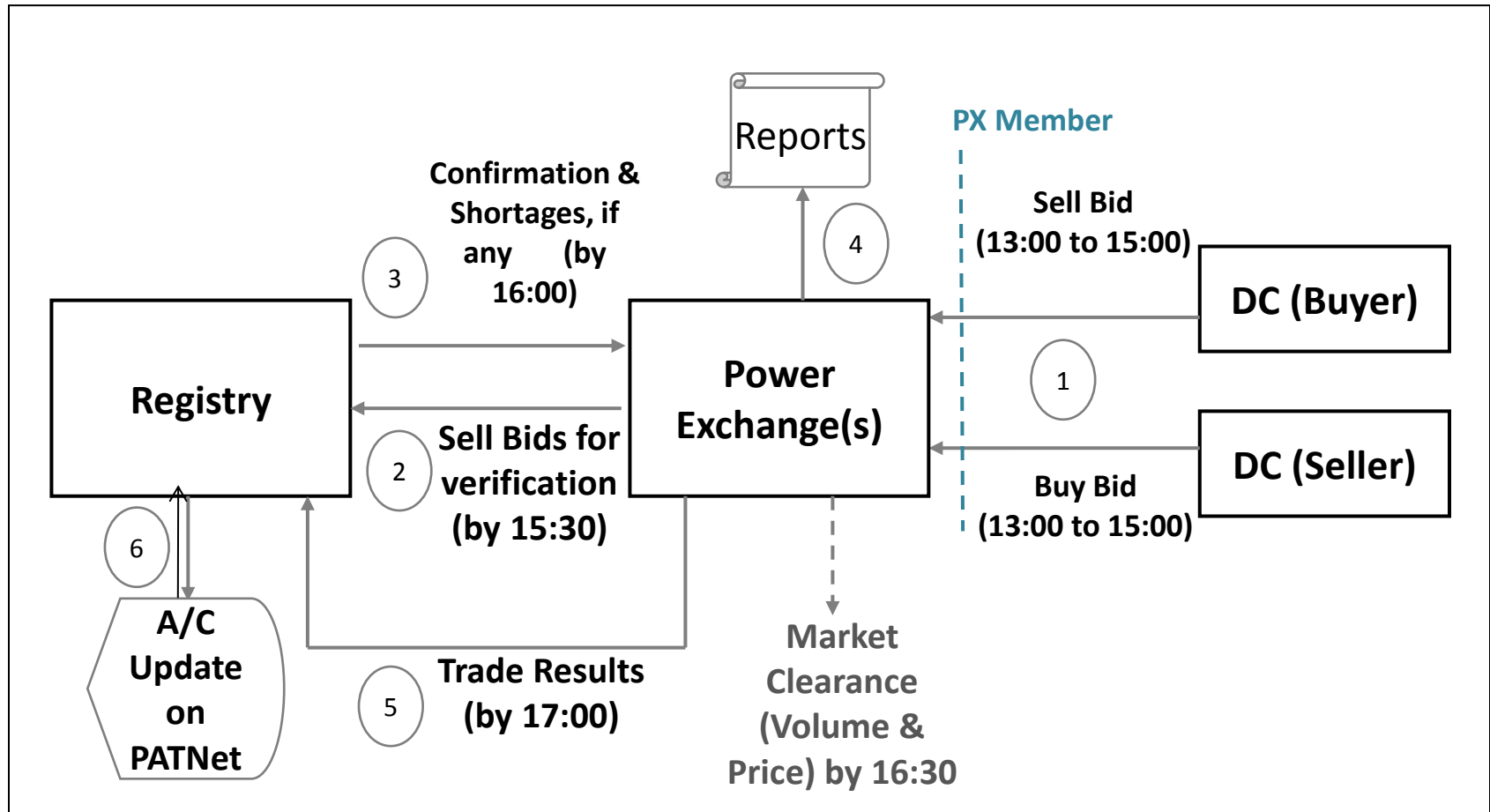

#The time shown above is the tentative time.

ACTIVITIES OF ESCerts TRADING ON POWER EXCHANGE

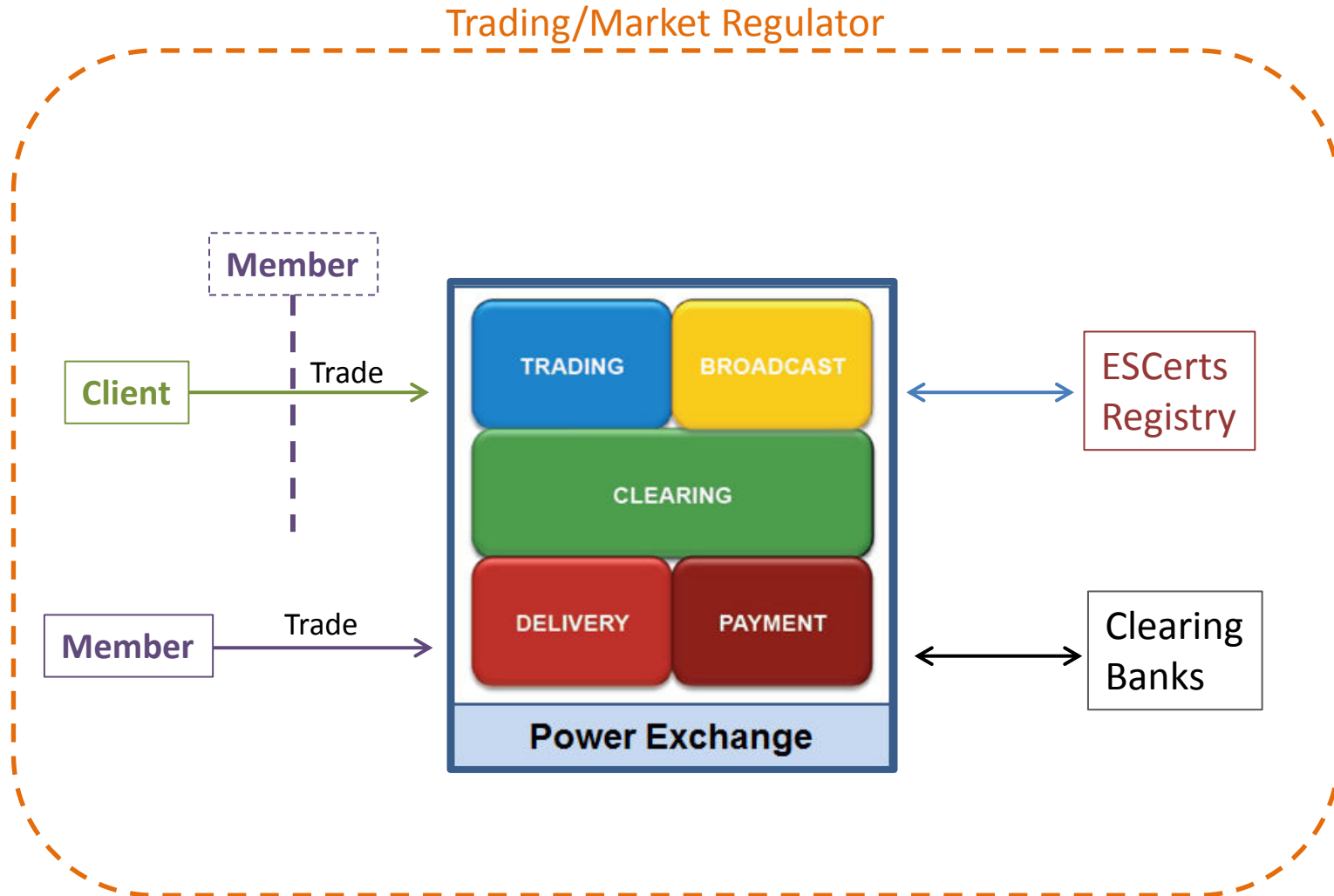

ADJUDICATION PROCESS FLOW

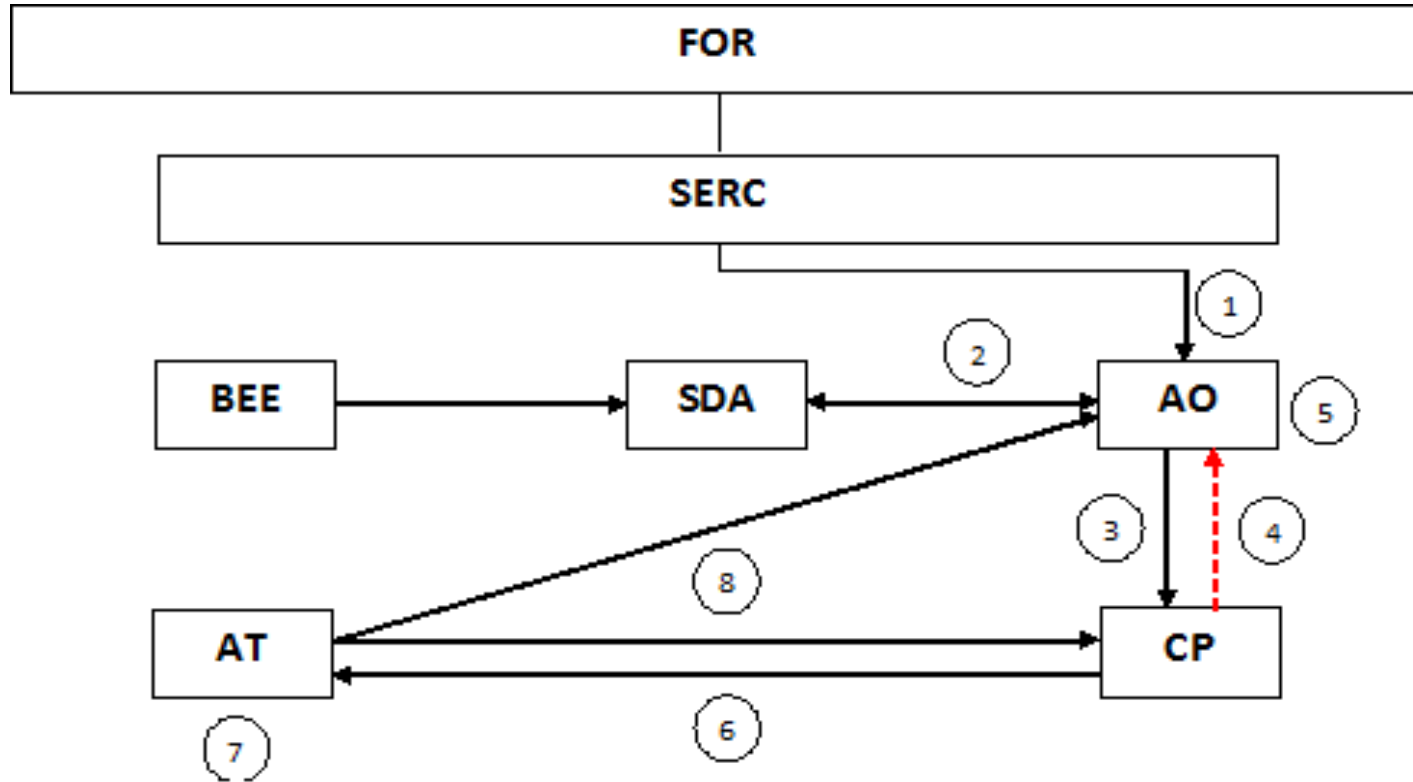

ENTITIES INVOLVED:

FOR : Forum of Regulators;
AO : Adjudicating Officer
BEE : Bureau of Energy Efficiency
CP : Concerned Person

SERC : State Electricity Regulatory Commission
SDA : State Designated Agency
AT : Appellate Tribunal



THANK YOU FOR KIND ATTENTION

BUREAU OF ENERGY EFFICIENCY

A Statutory body under Ministry of Power, Government of India

4th Floor, Sewa Bhawan, R. K. Puram, New Delhi – 110 066

Ph: +91- 11- 2617 9699 | Fax: +91- 11- 2617 8352 | Email: gshankar@beenet.in

तेन (समस्त ऊर्जा को) त्यक्तेन (त्याग के साथ) मुंजीथः (उपयोग करे)
-----ईशावास्योपनिषद्